

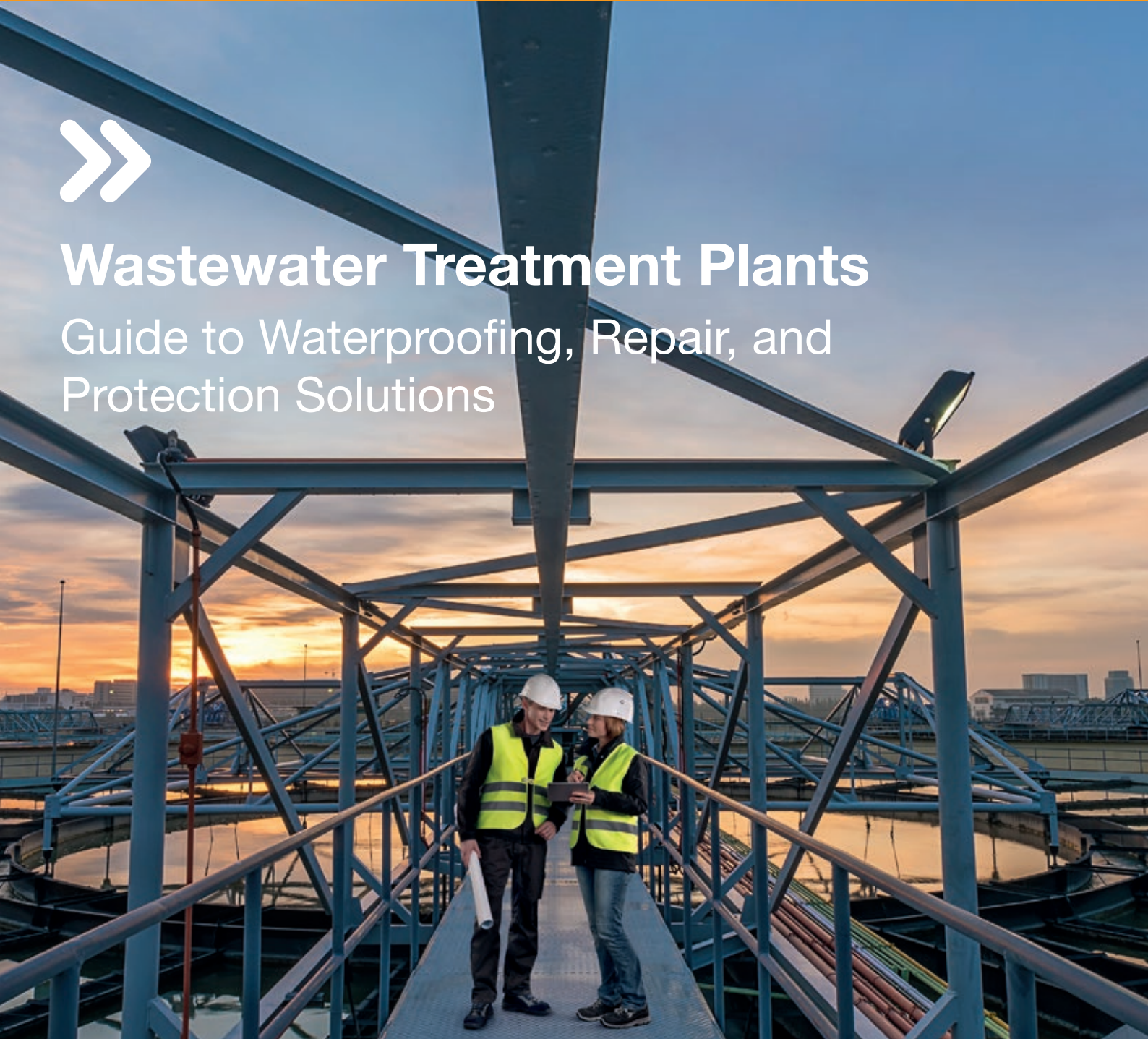

# Wastewater Treatment Plants

Guide to Waterproofing, Repair, and Protection Solutions







## Solutions for Structures Exposed to a Demanding Environment

We have more than a century of experience in waterproofing, repairing, and protecting concrete. This knowledge enables us to offer the best comprehensive solutions for the corrosive environment of wastewater facilities. Master Builders Solutions technologies are strenuously tested to ensure high performance.

Water purification is a complex and challenging process. Highly differentiated structures, tanks, and stations have to perform several distinct tasks. A perfect result – clean and potable water – can only be achieved if the whole

water treatment system is perfectly protected. We deliver an optimized solution for every part of the process: waterproofing, repair, and protection.

### 360° Protection

MasterSeal 7000 CR – our unique waterproofing and concrete protecting system for extreme conditions – see page 22

Solutions for exposed structures		Page
	<b>Your Innovative Partner for Urban and Industrial Wastewater Management</b>	06
	<b>Our Solutions for the Water Treatment Process</b>	08
	▪ Primary sedimentation	10
	▪ Aeration and secondary sedimentation	12
	▪ Tertiary treatment	14
	▪ Sludge treatment	15
	▪ Storage and operation facilities	16
	▪ Up- and downstream installations	18
	<b>Master Builders Solutions Compatible Product Portfolio</b>	20
	▪ Waterproofing and protection membranes	21
	▪ Detailing and joint treatment	29
	▪ Concrete protection	30
	▪ Substrate preparation and reinforcement	32
	<b>Risk Management: From Products to Successful Projects</b>	36





## The Best Protection for an Essential Resource

Growing commitment to environmental protection and sustainability, as well as the cost of water, have led to an increased need for the treatment of urban wastewater and reuse of water at industrial plants. As a reliable partner, we help our customers to protect the durability of their assets and operations without unexpected downtime. Because it's all about the main element of life: water. »





## Your Innovative Partner for Urban and Industrial Wastewater Management

**Wastewater treatment plants have to deal with an extreme environment:** suspended solids, organic matter, bacteria, or contaminated water are tough challenges for treatment tanks, pipelines, and pumping stations. Master Builders Solutions offers a range of systems to ensure efficient, safe, and continuous operation of your treatment plant.

### Urban wastewater

Domestic wastewater treatment is intended to remove contaminants from water, to produce clean potable water, and generate solid waste that is suitable for reuse or discharge into the environment.

#### Harsh conditions for construction materials

Some of the harshest and most demanding conditions for construction materials are found at wastewater treatment plants:

- The usual long-term threats to reinforced concrete, such as carbon dioxide, acid rain, and freeze-thaw cycles
- Turbulent water flows and suspended solids, which cause erosion and abrasion
- High sulphate levels and biogenically induced acid formation, which create an aggressive environment

The effects of such treatment can lead to rapid deterioration of concrete surfaces and corrosion of concrete reinforcement and steel structures. Suitable protection extends their life cycle, while reducing maintenance downtime and refurbishment costs.

#### Health and safety standards

To comply with modern quality standards, the chemical concentration of discharged water needs to be reduced. Also the vicinity must be protected against unpleasant odours. One approach is to encapsulate tanks, but this results in hotter temperatures, higher concentrations of anaerobic bacteria and more corrosive conditions.

### The hydrogen sulfide (H<sub>2</sub>S) problem

One of the best known but least understood issues in wastewater treatment is the formation of hydrogen sulfide. This substance, which is released by bacteria present in

wastewater, may create a number of problems: it causes headaches and eye irritation and corrodes on metal and concrete structures.



### Industrial wastewater

Large quantities of water are used in many industrial activities, not only as a raw material but also as a cooling medium and cleaning agent. Industrial wastewater may also include contaminated storm water and leachate from industrial solid waste facilities.

#### Reusing water – a scarce resource

The approach used for developing industrial wastewater treatment systems is entirely different from that of domestic wastewater treatment. In order to design the best possible facilities, a deep chemical analysis of the wastewater must be carried out.

The treatment required also depends on the destination of water after treatment, which must be clearly defined:

- The quality required of the water to be reused in the same plant depends on where in the process it will be reused
- Treated wastewater discharged to another treatment facility must comply with the treatment requirements of that facility
- Treated effluent discharged to an open body of water must meet the requirements of applicable national or local regulations

#### Wastewater Equalization – specific solutions needed to protect wastewater infrastructures

Industrial treatment processes are more effective if the wastewater inflow is standardized by equalizing the water stream. Wastewater treatment is normally optimized for limited concentration ranges of target pollutants and does not perform well if the concentrations of these pollutants are significantly outside the designated range.

### Biogenic acids

Once the hydrogen sulfide has reached the surface, it is converted into sulfuric acid by thiobacillus thiooxidans, an aerobic bacterium present in wastewater. Generally it was thought that the pH could be as low as 2, but under certain conditions it can be as low as 0.5. In this case concrete and metal structures will be exposed to severe corrosion.

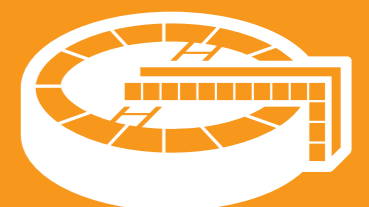



# Our Solutions for the Water Treatment Process



Each step in wastewater treatment requires a specific approach. Both the waterproofing, repair, or protection product used and the design of the solution must be adapted to the specific chemical and mechanical aggressiveness of the incoming water. The required purity level of the treated water generated also influences the chosen solution.

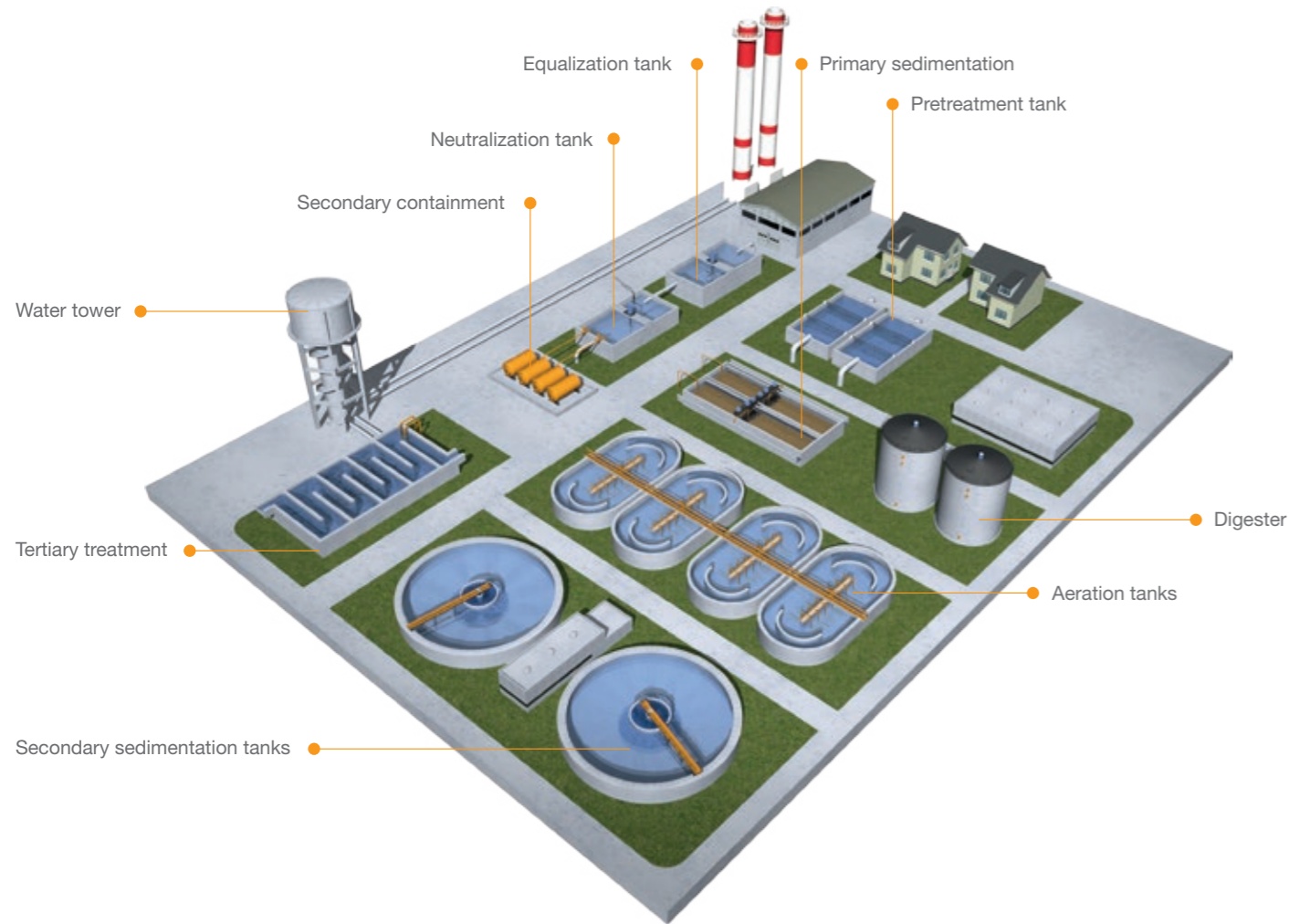

Shorten the downtime



Extend the life cycle



Increase safety

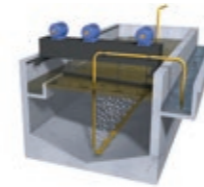

## Pretreatment and primary sedimentation

10

Pre- and primary treatment include screening (which eliminates bulky waste), sandblasting (which removes sand), de-oiling (which removes fatty substances) and primary decantation. This step removes coarse elements.

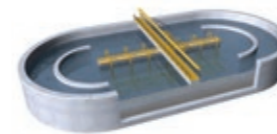

## Aeration and secondary sedimentation Biological and/or chemical treatment

12

Secondary treatment is often biological, but a physicochemical pathway can be substituted or added. The physicochemical treatment allows for better coagulation of the sludge and particularly favors the fixation of the phosphates that come from agricultural activities. Secondary treatment includes oxygenation, in which oxygen is inserted into the water to remove the remaining fatty substances, and secondary decantation, which extracts a secondary amount of sludge.



## Tertiary treatment

14

The objective of the optional tertiary treatment is to eliminate undesirable elements, such as phosphorus, nitrates, and certain compounds (e.g. pesticides, metals, and detergents). The aim is to improve the quality of purified water before injection into the environment or reuse.

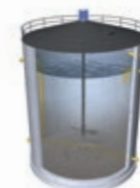

## Sludge treatment

15

The treatment of sludge is carried out in parallel with the water treatment when the mud is harvested from the settling ponds and during clarification. The sludge is digested for the production of biogas before being stabilized and dehydrated.



## Storage and operation facilities

16

Additional storage units, such as equalization tanks, as well as operation and technical buildings where high concentrations of chemicals are handled must also be waterproofed and protected.



## Down- and upstream installations

18

Water is delivered to the wastewater plant by means of many pipes and pumps, which suffer from mechanical and chemical attack. These too, need to be maintained and repaired. Once filtered and treated, the water goes back to the environment or is stored in a potable water tank.





## Pretreatment

### Removal of large solids

Typically in urban wastewater treatment, sand, gravel, and rocks can be easily collected from the raw wastewater and disposed of, while lighter particles and organic matter pass through to the primary sedimentation phase.

The screening channel, which eliminates sand, grit, or other hard particles, is exposed to various types of contaminants:

- Leftover solid waste in the water, which causes mechanical damage, abrasion, and erosion
- Urban pollution and other chemicals in the water, which cause chemical damage

A combination of these attacks leads to concrete deterioration, cracks and even joint damages.

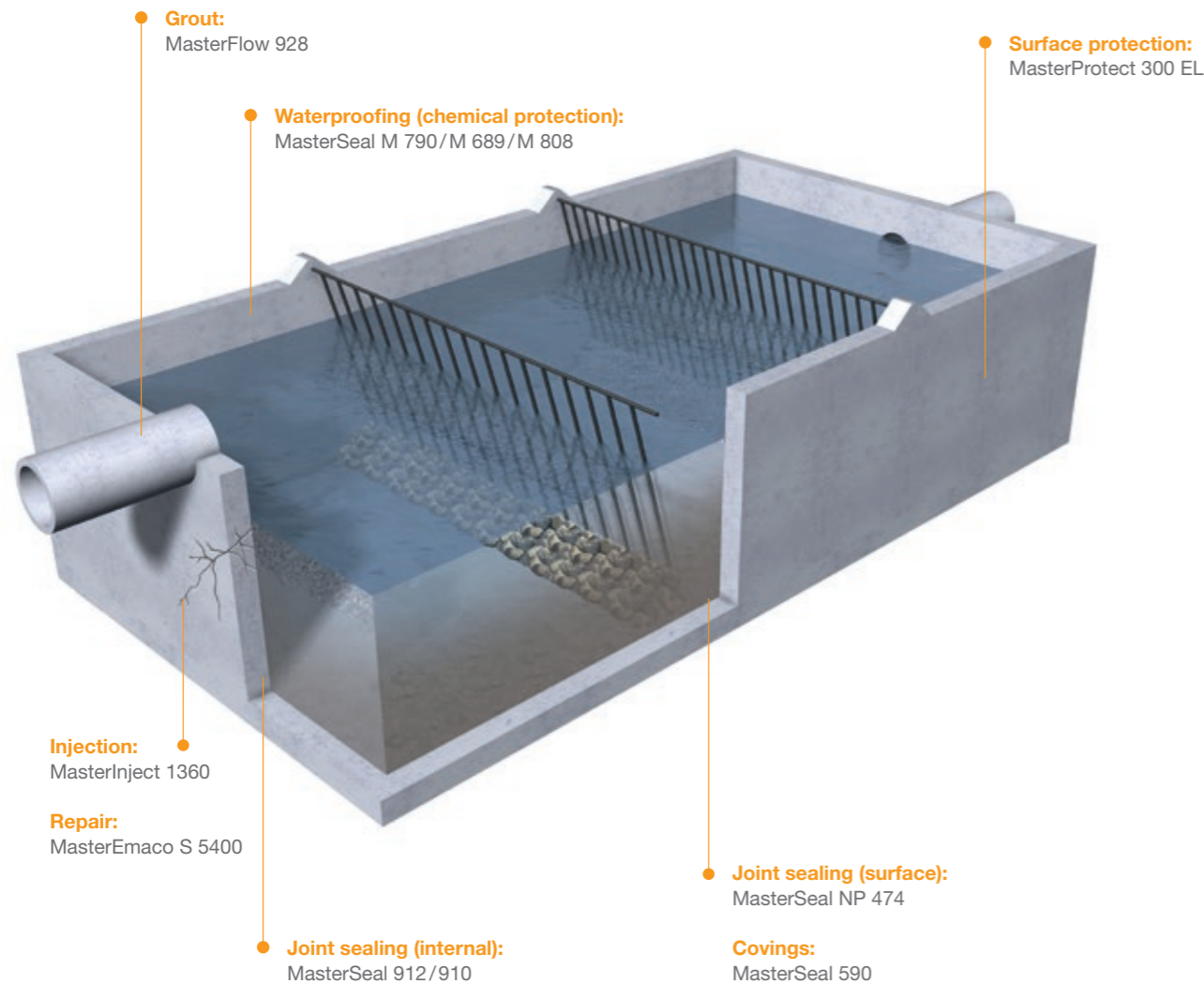

## Primary Sedimentation Tanks

Larger particles in the water settle to the bottom, while grease and oils rise to the surface where they can be skimmed off. This settling process is assisted in certain cases by the addition of chemicals or air.

### Physical separation of components

The particles and chemicals that settle to the bottom are then transferred to the sludge collection well, while the wastewater continues to the "activated sludge treatment phase".

The main risks during this phase are:

- Chemical damage caused by aggressive waste or industrial water that can lead to leakage (in case of improper waterproofing) and steel reinforcement corrosion (due to unsuitable protection)
- Mechanical abrasion caused by the rolling wheel

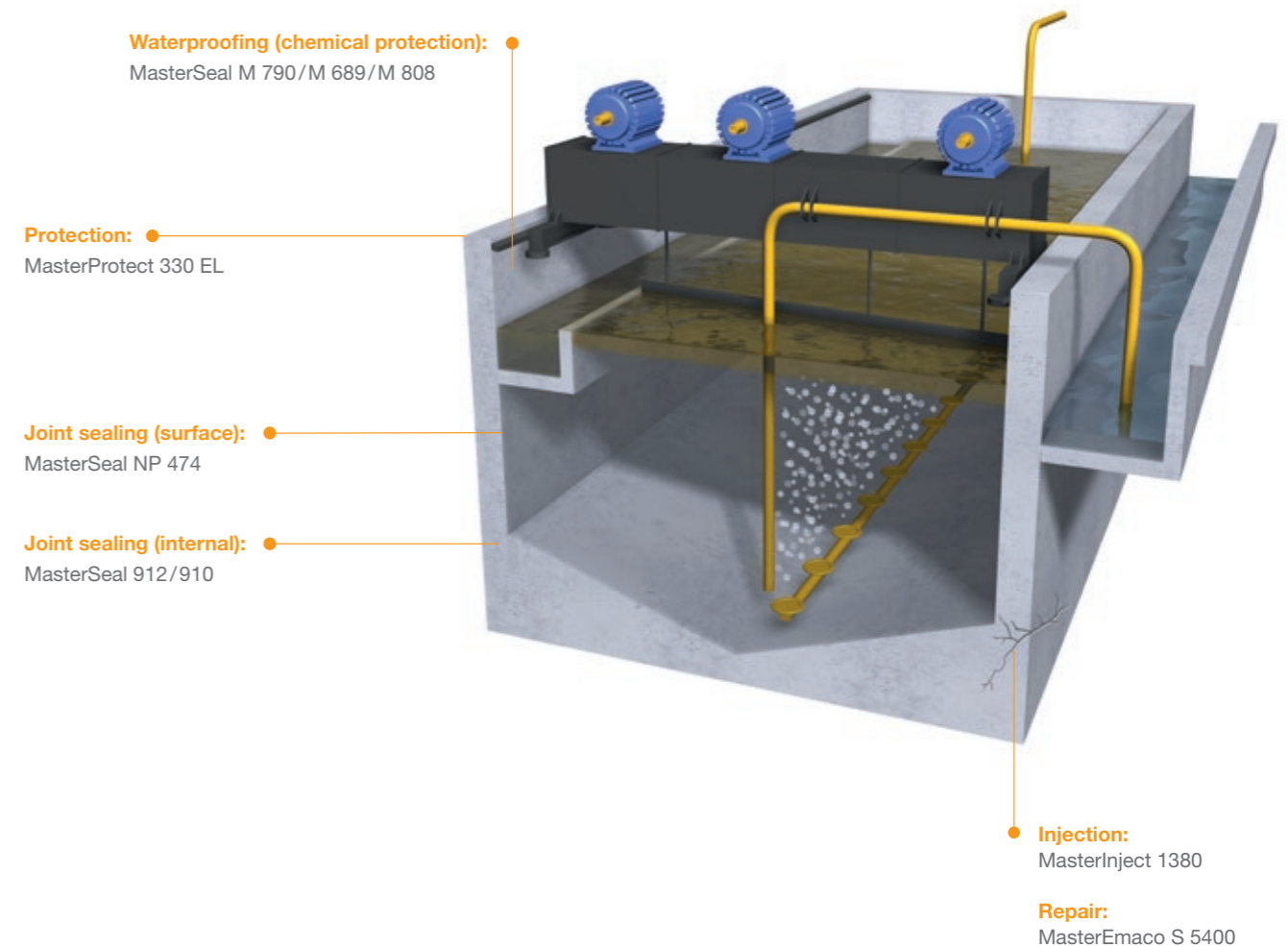



## Aerated Biological Treatment

Typically with a plentiful supply of air, microorganisms in biological treatment convert the remaining dissolved or colloidal organic matter into solids that can be precipitated.

### Biological degradation of organic matter

The most common configuration is an activated sludge system consisting of two steps: an aeration tank and a secondary sedimentation tank or clarifier.

Strong water flow and leftover chemicals in the water lead to:

- Erosion of the waterproofing membrane or concrete
- Chemical attack

Erosion and chemical attack wears down the waterproofing, while the steel reinforcement corrosion causes cracks, further increasing the deterioration process.

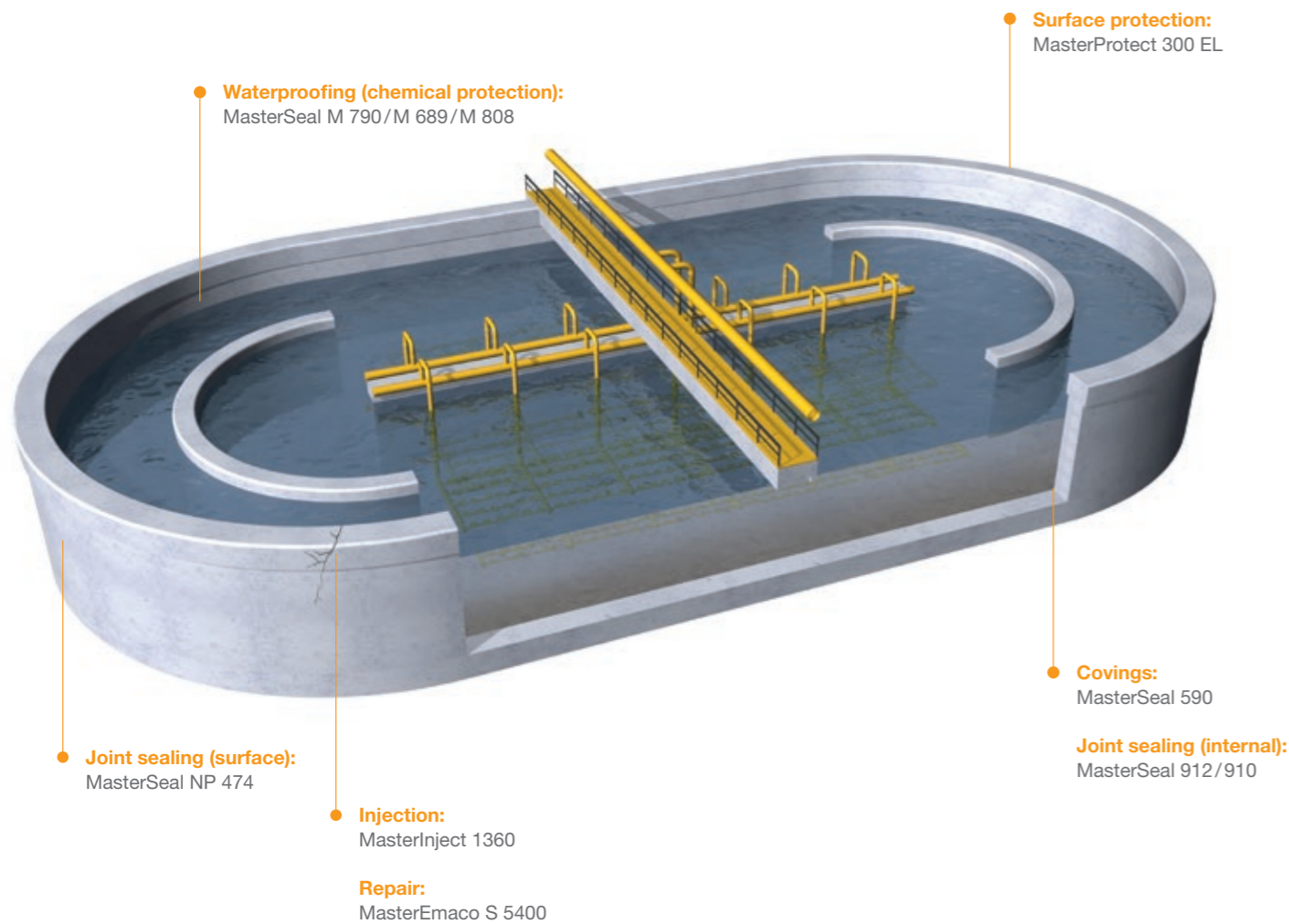

## Secondary Sedimentation Tanks

This is the final step in the secondary treatment process. By means of gravity, heavier particles settle to the bottom of the sedimentation tanks for removal from the wastewater.

### Separation of activated sludge solids from the wastewater

The majority of the material that settles to the bottom is transferred to the sludge collection well. The remainder is recycled and returned to the activated sludge system to keep the microbe population sufficiently high to digest the organic matter at the desired rate.

The main concerns for secondary sedimentation tanks are:

- Waterproofing and protection
- The upper part of the concrete basin, which is often eroded by the rolling wheel (see page 32)

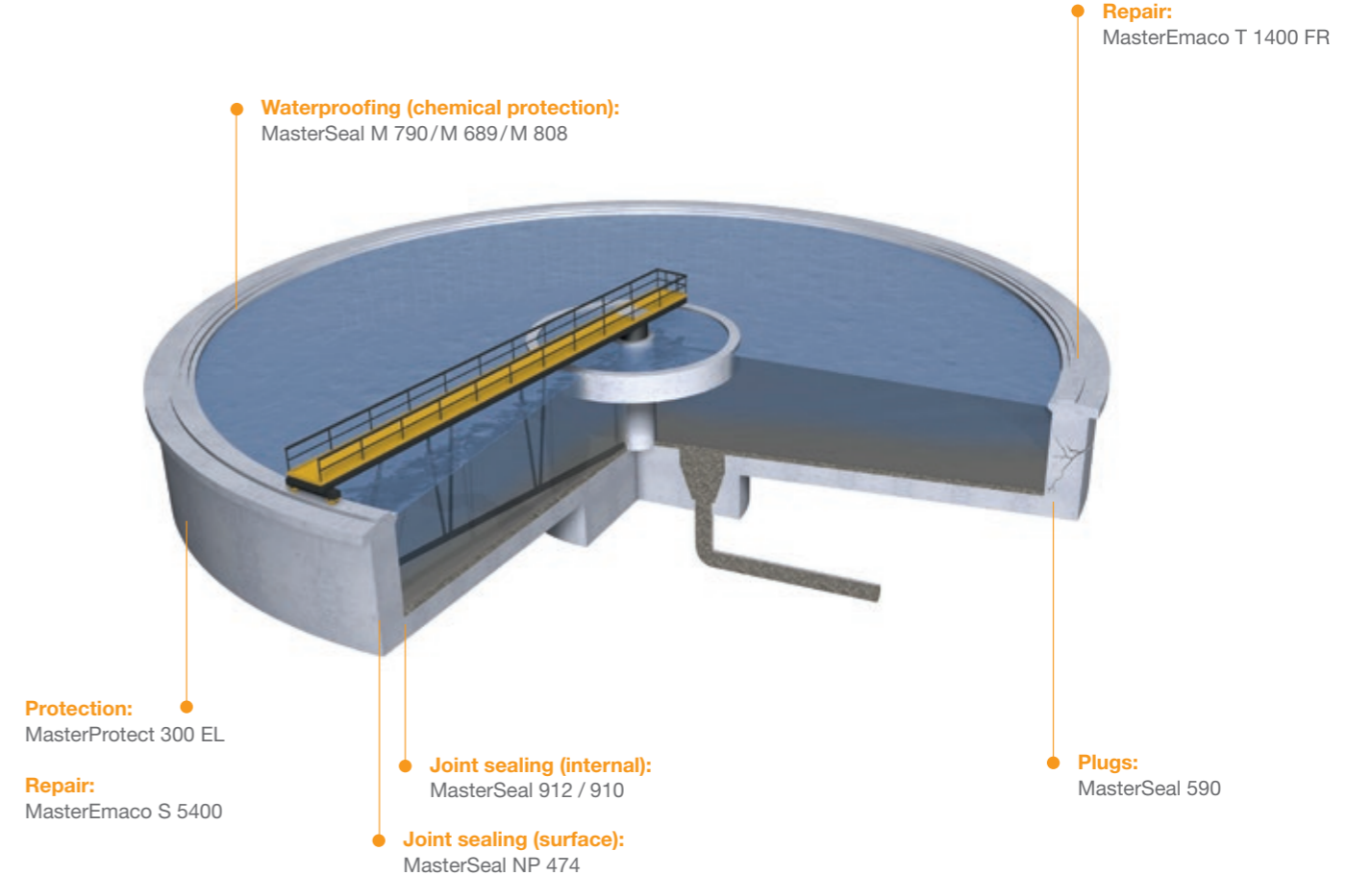



## Tertiary Treatment

Tertiary treatment is an additional processes that eliminates undesirable elements such as nitrates, phosphorus, and other compounds (e.g., pathogens, pesticides, metals, and detergents). It aims to improve the quality of the purified water.

Water undergoes tertiary treatment if it is required in a sensitive environment or other special applications. Such treatment can be found at both an urban and industrial wastewater treatment plant.

The main concerns for tertiary treatment are:

- Damage caused by the strong abrasion of moving sand in water tanks
- Cracks in the waterproofing and protection membrane, which can occur as a result of the thermal expansion of concrete, shrinkage, or corrosion of steel reinforcement

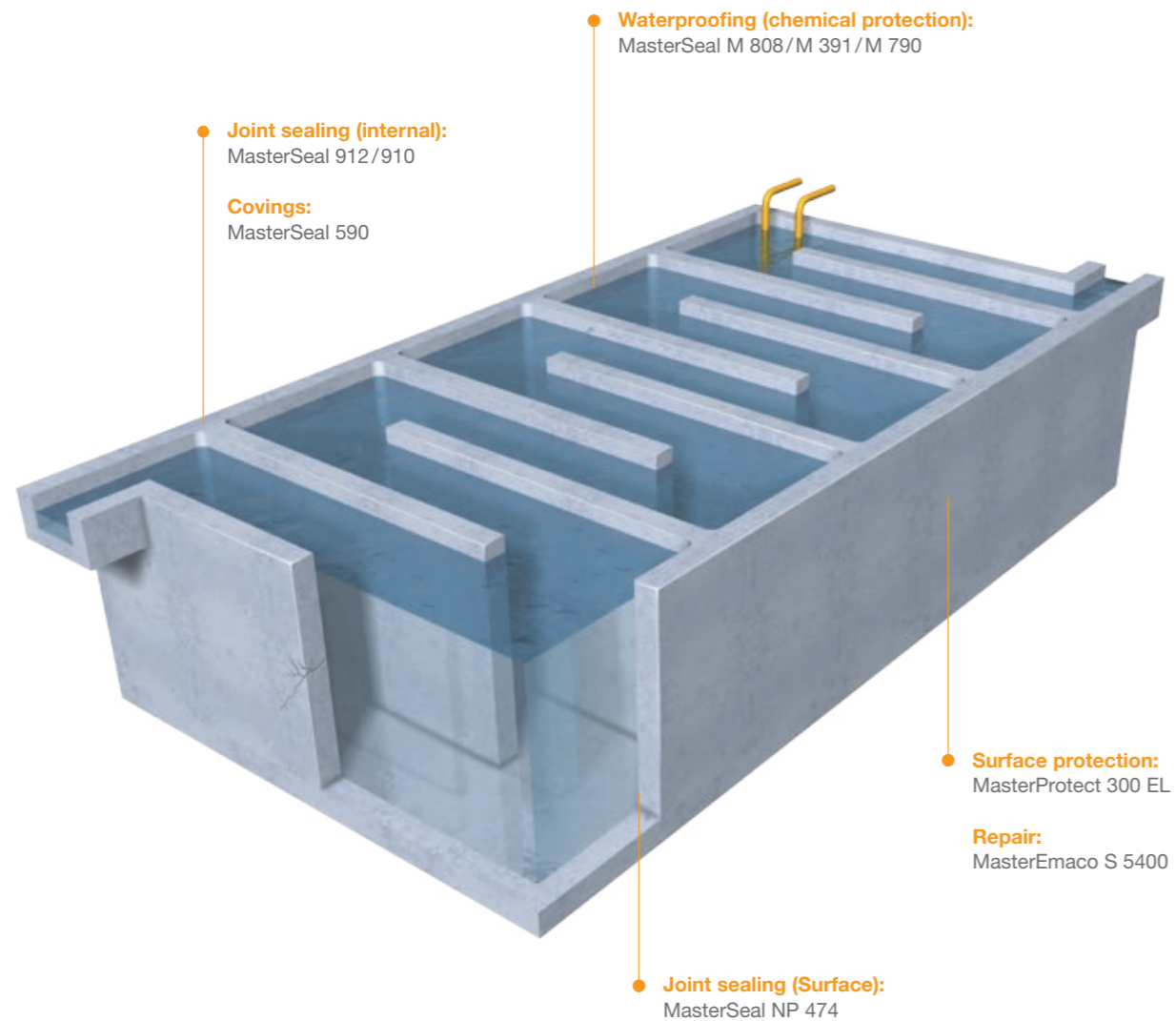

## Sludge Treatment

### Digesters

The sludge produced in the primary and secondary settlement tanks is treated in a series of processes in which microorganisms break down biodegradable material prior to its final disposal.

The environment inside the digesters is very harsh and predominantly sulfurous, which can very quickly damage concrete if the waterproofing and protection membrane is defective in any way.

### Sludge treatment

This process produces a mixture of gases, including methane and carbon dioxide (sometimes contaminated with hydrogen sulfide). This gas can be burned to heat the digester tank or used as fuel for another purpose.

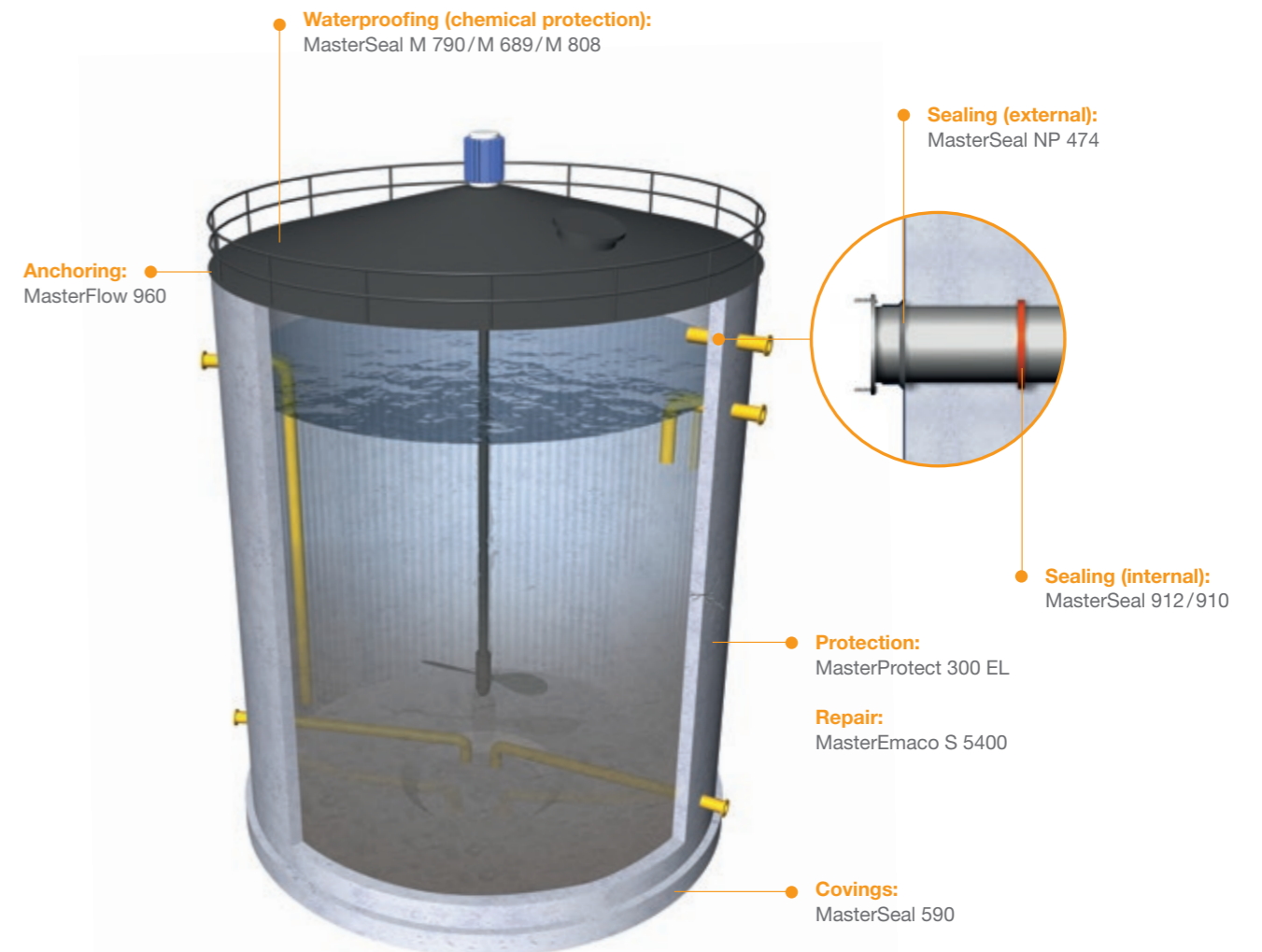





## Storage Facilities

### Equalization tanks

Water flow at urban wastewater treatment facilities changes as a result of variations in its diurnal cycle and major precipitation overflows. Flow equalization throughout the processing and clean-up cycles is thus required.

### Regulation of flow rates

Typically, large ponds or lagoons are constructed at various intervals up- or downstream from the grit removal areas. These ensure a steady inflow rate and may be exposed to high chemical stress.

Variations in the chemical composition of the wastewater must be analyzed and determined in order to select the appropriate waterproofing membrane and ensure its durability.

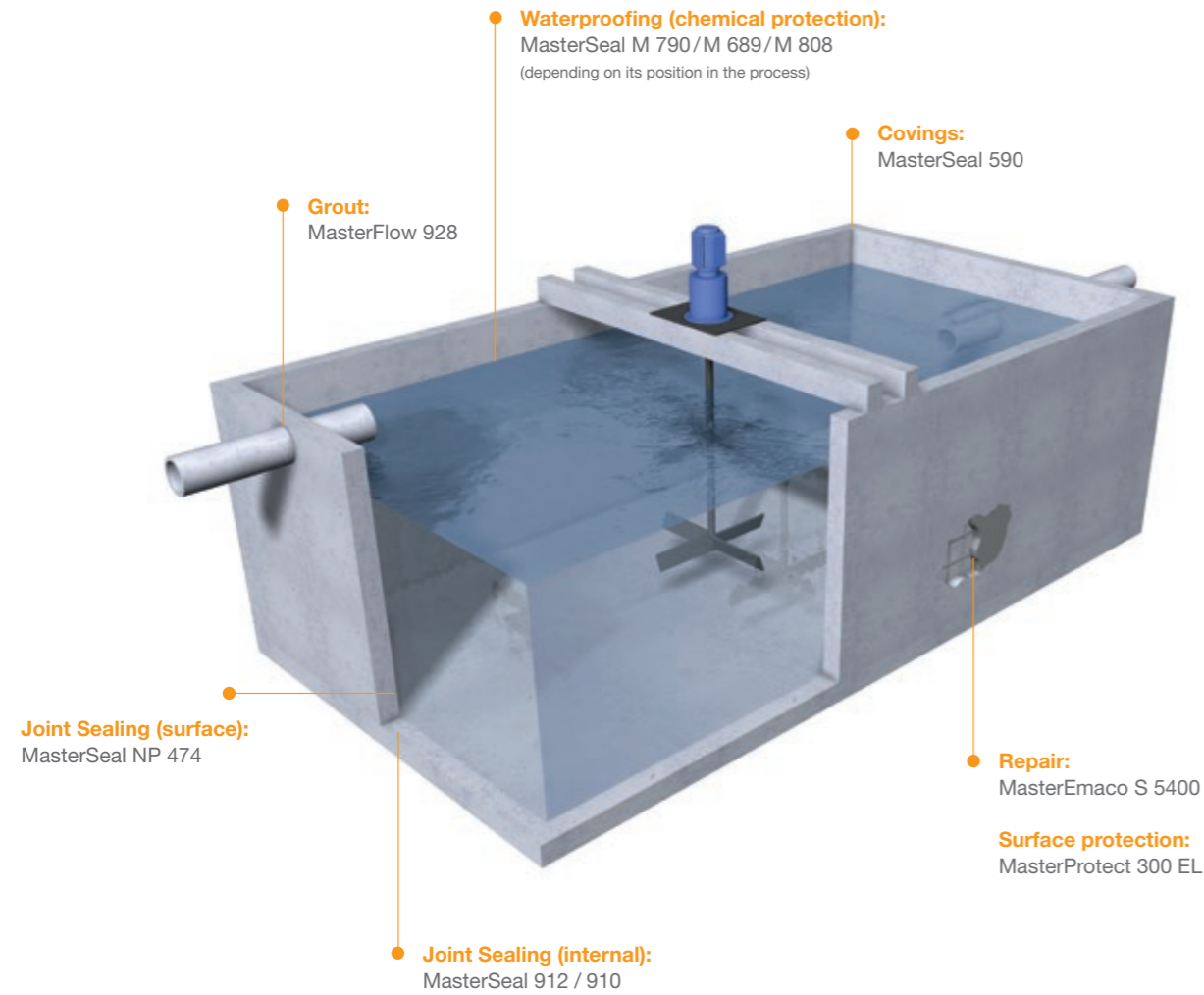

## Operation Facilities

### Operation and technical buildings

Operation facilities have specific requirements as chemical products for wastewater treatment basins are stored, prepared, and handled here. While the protection of such buildings is low because permanent immersion of high concentration chemicals is unexpected, spillages will eventually occur. Mechanical demands are quit low as normally these areas are not exposed to regular vehicle traffic.

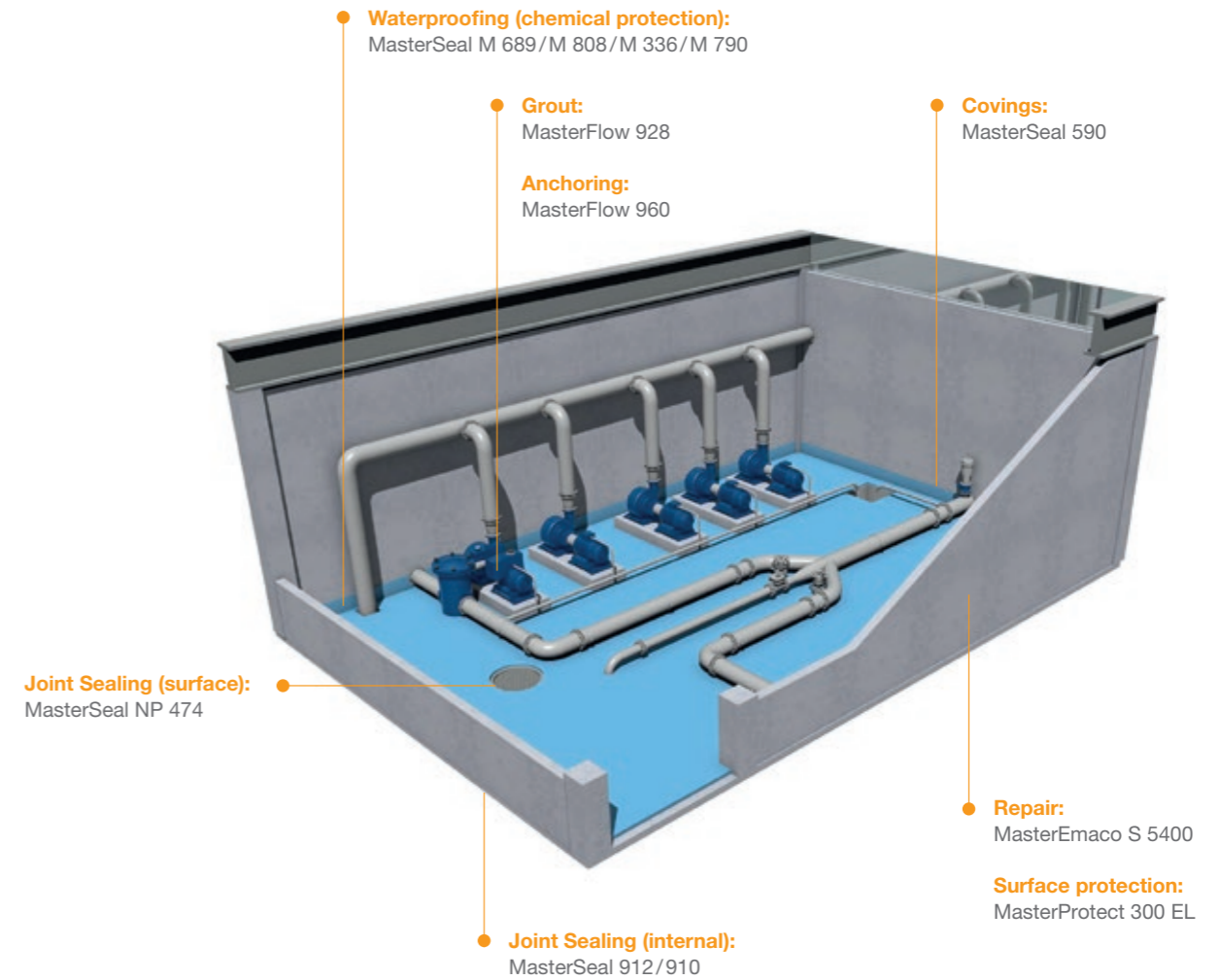





## Upstream

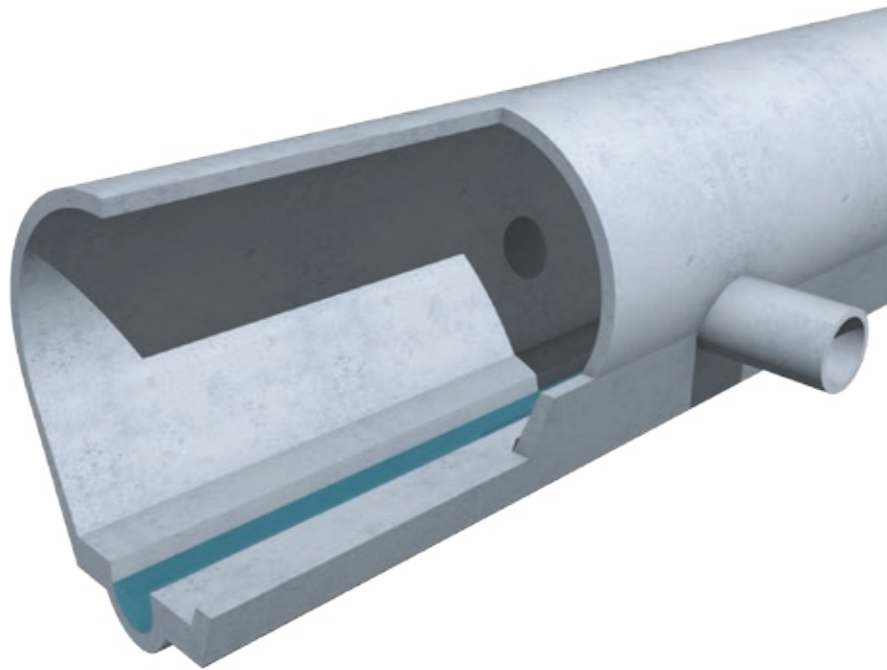

### Conduits, channels, and pipelines

Conduits, channels, and pipelines carry wastewater and the treated effluent from the treatment plant to its discharge point. Mechanical and chemical damage varies depending on the type of water being transported and on whether the conduits are open or closed.

Waterproofing (chemical protection)	MasterSeal M 689/M 808/M 790/560
Joint sealing (internal)	MasterSeal 912/910
Joint sealing (surface)	MasterSeal NP 474
Surface protection	MasterProtect 330 EL
Repair	MasterEmaco S 5400
Covings	MasterSeal 590

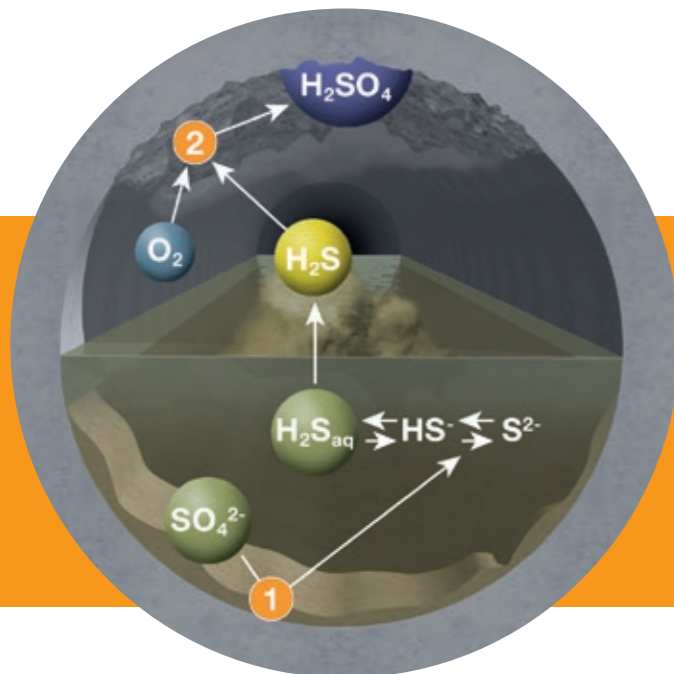

### Dealing with aggressive environments

Sewer pipes and pump chambers in anaerobic environments might be the site of a complex attack phenomenon:



## Downstream



### Potable water tanks

Treated water is normally discharged directly to a river or stream, but in certain cases is stored for internal use or to regulate water flow. If stored for human consumption, treated water must reach the expected level of purity in accordance with local regulations.

Waterproofing	MasterSeal M 808/M 391/560
Joint sealing (internal)	MasterSeal 912/910
Joint sealing (surface)	MasterSeal NP 474/930/933
Surface protection	MasterProtect 330 EL
Repair	MasterEmaco S 5400
Covings	MasterSeal 590

- The water carried through the pipes contains sulfur compounds that bacteria convert into hydrogen sulfide ( $H_2S$ ), which escapes from the sewage water ①.
- This gas may be oxidized by other bacteria, transforming it into sulfuric acid ( $H_2SO_4$ ), which attacks concrete

because of its very low pH. This phenomenon is known as Biogenic sulfuric acid corrosion ②.

- The acid attack occurs in the upper part of sewers and can reduce concrete thickness by 6 to 12 mm per year if left unprotected.





# Master Builders Solutions Compatible Product Portfolio

## Waterproofing and protection membranes

### MasterSeal resin-based elastic membranes

Based on epoxy, polyurethane, polyurea, or our new advanced technology Xolutec, MasterSeal membranes offer maximum waterproofing capacity and resistance to several types of chemicals – even in direct contact with contaminated water.



### MasterSeal elastic cementitious membranes

Our elastic cementitious waterproofing membranes are a good alternative to resin-based solutions if special chemical resistance is not required. They are suitable for structures containing water, such as tanks and reservoirs.



## Detailing and joint treatment

### MasterSeal detailing products and joint sealants

A complete toolkit of ancillary products for any individual design configuration, MasterSeal ensures maximum effectiveness of the waterproofing membrane.



## Concrete protection

### MasterProtect coatings

MasterProtect is our solution for protection against carbonation and chloride attack in areas unexposed to constant immersion.



## Substrate preparation and reinforcement

### MasterEmaco, MasterInject, and MasterFlow concrete repair mortars

Our full range of solutions includes concrete repair mortars, injection resins, grouts, and anchoring for proper substrate preparation.



# Waterproofing and Protection Membranes

The balance between crack-bridging and chemical-resistant membranes

## MasterSeal waterproofing membranes

For environments subject to chemical contamination, a waterproofing solution must offer more properties and benefits than preventing the egress of water from tanks.

Until it is purified, water containing aggressive chemicals must be isolated, not only from the environment but also from concrete and steel structures. These need to be chemical-resistant and highly elastic to prevent contaminants from penetrating the substrate through even the smallest crack and thus progressively damage it.

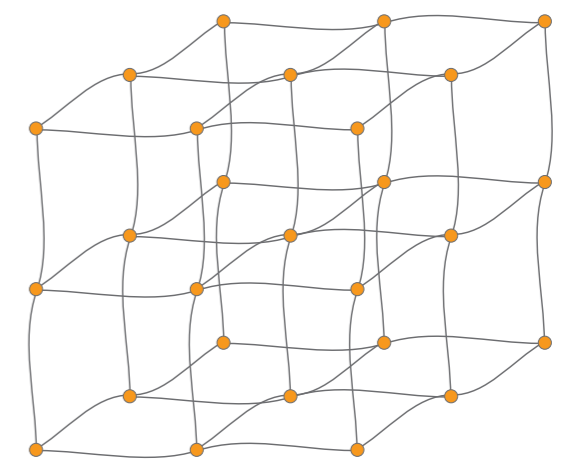
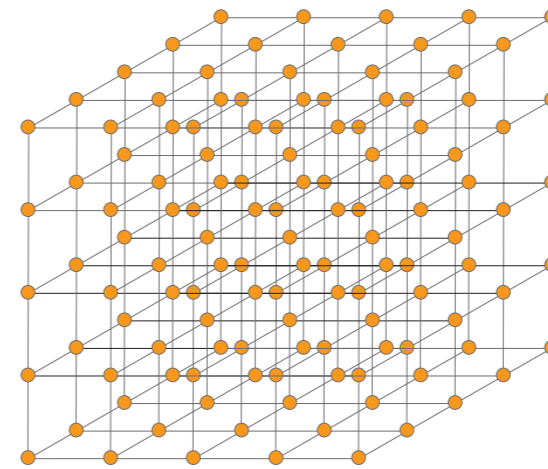

The resistance of a membrane to contaminated water depends on the density and cohesion of the cross-linking macropolymer structure created during hardening.

But at the same time, crack-bridging, elastic membranes must have a polymer network that allows the molecules the maximum freedom of movement.



Densely cross-linked polymers have higher chemical resistance and lower elasticity. But there are exceptions.

**MasterSeal M 790, M 689, and M 808** combine highly dense cross-linked polymers with great flexibility.

To achieve highly elastic, crack-bridging properties, as well as extraordinary chemical resistance,

That is the reason our MasterSeal products are both chemical-resistant and highly elastic – a unique membrane for unique performance!





# MasterSeal 7000 CR System

## Properties

Chemical resistance

●●●●●

Crack-bridging

●●●○●

1 Primer  
MasterSeal P 770

2 Membrane  
MasterSeal M 790

	Product	Thickness approx.	Consumption approx.
1 Primer	MasterSeal P 770 Special primer for MasterSeal M membranes applied on mineral (dry or humid) substrates	0.25 mm	0.3 kg/m <sup>2</sup>
2 Membrane	MasterSeal M 790 Waterproofing crack-bridging membrane based on Xolutec technology for harsh chemical environments	0.7–0.8 mm (in 2 coats)	0.8–1.0 kg/m <sup>2</sup> (in 2 coats)



## Recommended for

Equalization tanks	✓*	Secondary treatment (sedimentation tanks)	✓
Neutralization tanks	✓*	Tertiary treatment (disinfection)	–
Pretreatment	✓	Digesters (sludge treatment)	✓
Primary treatment (sedimentation tanks)	✓	Potable water tanks	–
Secondary treatment (aeration tanks)	✓		

\*Check suitability of the membrane against the chemical composition of tank content.



# MasterSeal 6689 System

## Properties

Chemical resistance

●●●●○

Crack-bridging

●●●●●

1 Primer  
MasterSeal P 770

2 Membrane  
MasterSeal M 689

	Product	Thickness approx.	Consumption approx.
1 Primer	MasterSeal P 770 Special primer for MasterSeal M membranes applied on mineral (dry or humid) substrates	0.25 mm	0.3 kg/m <sup>2</sup>
Alternative primer	MasterSeal P 385 Epoxy-cement based primer coat for MasterSeal M membranes applied on non-absorbent or damp mineral surfaces, exposed to negative and osmotic pressure	0.3–1.0 mm	0.5–1.5 kg/m <sup>2</sup>
2 Membrane	MasterSeal M 689 Elastomeric, 100% polyurea membrane for waterproofing concrete surfaces exposed to chemical or mechanical loads	2.0 mm (1 coat)	2.1 kg/m <sup>2</sup>



## Recommended for

Equalization tanks	✓*	Secondary treatment (sedimentation tanks)	✓
Neutralization tanks	✓*	Tertiary treatment (disinfection)	–
Pretreatment	✓	Digesters (sludge treatment)	Optional
Primary treatment (sedimentation tanks)	✓	Potable water tanks	✓**
Secondary treatment (aeration tanks)	Optional		

\*Check suitability of the membrane against the chemical composition of tank content.  
\*\*Check suitability with local regulations.





# MasterSeal 6808 System

## Properties



Chemical resistance

●●●○○



Crack-bridging

●●●●●

- 1 Primer  
MasterSeal P 770
- 2 Membrane  
MasterSeal M 770



	Product	Thickness approx.	Consumption approx.
1 <b>Primer</b>	MasterSeal P 770 Special primer for MasterSeal M membranes applied on mineral (dry or humid) substrates	0.25 mm	0.3 kg/m <sup>2</sup>
Alternative primer	MasterSeal P 385 Epoxy-cement based primer coat for MasterSeal M membranes applied on non-absorbent or damp mineral surfaces, exposed to negative and osmotic pressure	0.3–1.0 mm	0.5–1.5 kg/m <sup>2</sup>
2 <b>Membrane</b>	MasterSeal M 808 Two component elastic polyurethane membrane with high chemical resistance. Approved for potable water contact	2 coats: 0.5 mm 3 coats: 0.8 mm	2 coats: 0.7 kg/m <sup>2</sup> 3 coats: 1.0 kg/m <sup>2</sup>



## Recommended for

Equalization tanks	✓*	Secondary treatment (sedimentation tanks)	✓
Neutralization tanks	✓*	Tertiary treatment (disinfection)	✓
Pretreatment	✓	Digesters (sludge treatment)	✓
Primary treatment (sedimentation tanks)	✓	Potable water tanks	✓**
Secondary treatment (aeration tanks)	✓		

\*Check suitability of the membrane against the chemical composition of tank content.  
\*\*Check suitability with local regulations.



# MasterSeal 6336 System

## Properties



Chemical resistance

●●○○○



Crack-bridging

●●●○○

- 1 Primer  
MasterSeal P 770
- 2 Membrane  
MasterSeal M 336

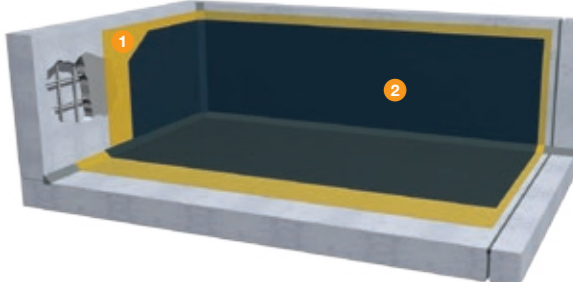

	Product	Thickness approx.	Consumption approx.
1 <b>Primer</b>	MasterSeal P 770 Special primer for MasterSeal M membranes applied on mineral (dry or humid) substrates	0.25 mm	0.3 kg/m <sup>2</sup>
Alternative primer	MasterSeal P 385 Epoxy-cement based primer coat for MasterSeal M membranes applied on non-absorbent or damp mineral surfaces, exposed to negative and osmotic pressure	0.3–1.0 mm	0.5–1.5 kg/m <sup>2</sup>
2 <b>Membrane</b>	MasterSeal M 336 Two component elastic epoxy-polyurethane waterproofing membrane with medium chemical resistance	2 coats: 0.4 mm 3 coats: 0.6 mm	2 coats: 0.5 kg/m <sup>2</sup> 3 coats: 0.75 kg/m <sup>2</sup>



## Recommended for

Equalization tanks	–	Secondary treatment (sedimentation tanks)	Optional
Neutralization tanks	–	Tertiary treatment (disinfection)	–
Pretreatment	–	Digesters (sludge treatment)	Optional
Primary treatment (sedimentation tanks)	–	Potable water tanks	–
Secondary treatment (aeration tanks)	Optional		





# MasterSeal 6391 System

## Properties



Chemical resistance  
● ○ ○ ○ ○



Crack-bridging  
○ ○ ○ ○ ○

- 1 Primer  
MasterSeal P 770
- 2 Membrane  
MasterSeal M 391

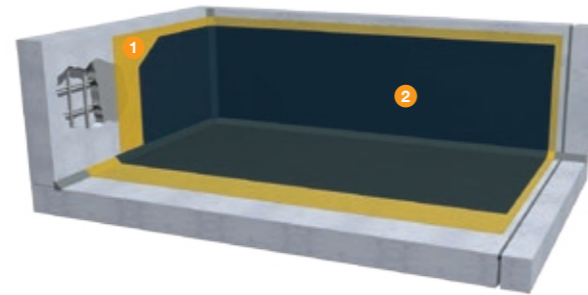

\*only for potable water

	Product	Thickness approx.	Consumption approx.
1 Primer	MasterSeal P 770 Special primer for MasterSeal M membranes applied on mineral (dry or humid) substrates	0.25 mm	0.3 kg/m <sup>2</sup>
Alternative primer	MasterSeal P 385 Epoxy-cement based primer coat for MasterSeal M membranes applied on non-absorbent or damp mineral surfaces, exposed to negative and osmotic pressure	0.3–1.0 mm	0.5–1.5 kg/m <sup>2</sup>
2 Membrane	MasterSeal M 391 Waterproofing membrane approved for contact with loads	2 coats: 0.4 mm 3 coats: 0.6 mm	2 coats: 0.6 kg/m <sup>2</sup> 3 coats: 0.9 kg/m <sup>2</sup>



## Recommended for

Equalization tanks	–	Secondary treatment (sedimentation tanks)	Optional
Neutralization tanks	–	Tertiary treatment (disinfection)	Optional
Pretreatment	–	Digesters (sludge treatment)	–
Primary treatment (sedimentation tanks)	–	Potable water tanks	✓**
Secondary treatment (aeration tanks)	Optional		

\*\* Check suitability with local regulations.



# MasterSeal 6560 System

## Properties



Chemical resistance  
● ○ ○ ○ ○



Crack-bridging  
● ● ● ● ○

- 1 Primer  
MasterSeal 560
- 2 Membrane  
MasterSeal 560



\*only for potable water

	Product	Thickness approx.	Consumption approx.
1 Primer	MasterSeal 560 Bonding slurry for MasterSeal 560	0.5 mm	0.6 kg/m <sup>2</sup>
2 Membrane	MasterSeal 560 Two-component, fast hardening, elastic and lightweight membrane for waterproofing and concrete protection. resistance. Approved for potable water contactloads	1 coat: 1.5 mm 2 coats: 2.5 mm	1 coat: 1.9 kg/m <sup>2</sup> 2 coats: 3.15 kg/m <sup>2</sup>



## Recommended for

Equalization tanks	–	Secondary treatment (sedimentation tanks)	–
Neutralization tanks	–	Tertiary treatment (disinfection)	–
Pretreatment	–	Digesters (sludge treatment)	Optional
Primary treatment (sedimentation tanks)	–	Potable water tanks	✓**
Secondary treatment (aeration tanks)	Optional		

\*\* Check suitability with local regulations.





## MasterSeal: High-performance Joint Sealants

Not only do surfaces need to be waterproofed, but so do the gaps between structural elements – especially so because they are susceptible to the egress of contaminated water. We specifically developed our MasterSeal joint sealant solutions to protect such areas.

The sealants are designed using high-performance elastomers to create a tenacious bond to a variety of substrates, ensuring protection under even the most demanding conditions. The bonds resist water and chemical attack over a long period, protecting the integrity of the structure in high-movement and -moisture environments.

### Treatment with bandage tape

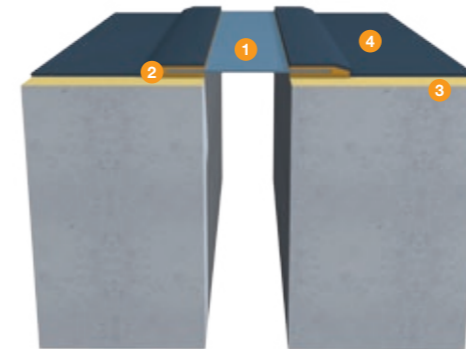

- 1 Bandage tape: MasterSeal 930
- 2 Adhesive for bandage tape: MasterSeal 933
- 3 Primer for membrane: MasterSeal P 770 or P 385
- 4 MasterSeal waterproofing membrane

### Treatment with joint sealant

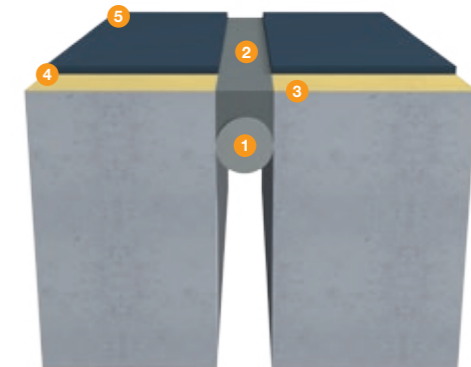

- 1 Backer rod: MasterSeal 920
- 2 Joint sealant: MasterSeal NP 474
- 3 Primer for joint sealant
- 4 Primer for membrane: MasterSeal P 770 or P 385
- 5 MasterSeal waterproofing membrane



## Compatible Products and Solutions

### Overview

- 29 \_ MasterSeal:  
High-performance Joint Sealants
- 30 \_ MasterProtect:  
Reliable Concrete Protection
- 32 \_ MasterEmaco:  
Substrate Preparation and Reinforcement

- 33 \_ MasterFlow:  
High-precision Grouts and Anchoring
- 34 \_ MasterInject:  
Injection for Concrete Structures







# MasterProtect: Reliable Concrete Protection



Many of the materials, chemical products, or product systems used to repair, protect, and structurally strengthen concrete today are chosen for their unique direct or indirect effects and specific characteristics.

### Long-term protection against chemical attack

The surfactant character of silane-based chemicals provides concrete with hydrophobic surface protection, whereas

acrylic-based wall coatings create a thin film to protect the concrete against the ingress of water.

Surface-applied corrosion inhibitors are effective because of their ability to penetrate deep into the concrete and form a protective layer around the reinforcing steel. They are suitable for exposed structures whose appearance must remain constant or whose coating is too expensive to reapply.

### Compatible MasterProtect products

<b>MasterProtect 8000 CI</b>	Surface-applied corrosion inhibitor treatment for chloride-contaminated and carbonated concrete structures
<b>MasterProtect H 303</b>	Water-based alkylalkoxysilane sealer for protection against freeze-thaw cycles and chloride intrusion
<b>MasterProtect 330 EL</b>	Water-based acrylic, elastomeric, exterior wall coating available in various colors

### The most cost-effective solution

Concrete protection is crucial for the longevity of cement structures and for repairing damaged surfaces to their original appearance and design function. The MasterProtect system includes a range of high-performance water repellents, corrosion inhibitor, anti-carbonation and chemical-resistant coatings that counteract the effects of challenging weather conditions, environmental contaminants, and corrosive elements.

### Exposure classes

The MasterProtect product selector table below will help you identify the best surface-applied protection solution system for your needs.

### MasterProtect product selector

	Decorative paint	Acrylic coatings	Corrosion inhibitors	Hydrophobic treatment	Resign based coatings
Environment	No risk of corrosion or attack	Carbonation-induced corrosion	Chloride-induced corrosion	Freeze/thaw attack	Aggressive chemical environment
Exposure class code	X0	XC1–XC4	XS1–XS3 XD1–XD3	XF1–XF4	XA1–XA3
Solution		MasterProtect 330 EL	MasterProtect 8000 CI	MasterProtect H303	E.g MasterSeal







## MasterEmaco: Substrate Preparation and Reinforcement

The main causes of wastewater treatment plant deterioration are chemical attack on the cementitious matrix of concrete, sulfuric acid attack in sewage pipes and other closed installations. The chemical attack is a result of the low pH levels of wastewater, while the sulfuric acid attack is caused by the anaerobic transformation of hydrogen sulfide by microorganisms, as well as the degradation of concrete due to dissolved chemicals in the wastewater.

### High-quality concrete repair

Concrete repair is a specialist activity requiring fully trained and competent personnel at all stages of the process.

Simple “patch and paint” strategies are often used for short-term cosmetic repairs, but these fail to address the root cause of the problem.

### Strategies in a specific environment – the key to a successful installation

Concrete might also be eroded by solids suspended in the water, especially in the early stages of treatment where such are transported by the water. Further damage unique to sedimentation tanks is the abrasion caused by the wheels that support and move the scraper.

### Compatible MasterEmaco products

<b>MasterEmaco S 5400</b>	Extra high-strength shrinkage-compensated fiber-reinforced thixotropic structural repair mortar
<b>MasterEmaco S 5440 RS</b>	Fast-setting and -hardening shrinkage-compensated fiber-reinforced thixotropic structural repair mortar
<b>MasterEmaco N 5200</b>	Universal fast-setting polymer-modified and fiber-reinforced repair and levelling mortar
<b>MasterEmaco T 1400 FR</b>	Fluid fast-setting and -hardening repair and road-nosing mortar reinforced with metallic and PAN fibers for concrete exposed to very high traffic loads



Repair of a sedimentation tank wall track with MasterEmaco T 1400 FR



## MasterFlow: High Precision Grouts and Anchoring

In wastewater treatment plants many pipes and tubes cross concrete walls which increases the risk of possible leakage. Turbines in pumping stations have to be properly installed and the large number of steel rods, rebars and scales must be securely fixed.

### Shrinkage compensation

High-precision grouts and anchoring must be used to prevent cracks, gaps and thus leakages.

### A solution for each specific case

The environment, future loads, chemical attacks and expected return to service determine which precision grout and anchoring to use.

### Compatible MasterFlow products

<b>MasterFlow 928</b>	Ready-to-use high-strength fluid nonshrink grout
<b>MasterFlow 648</b>	High-strength chemical-resistant epoxy-based precision grout
<b>MasterFlow 920</b>	Universal high-performance methacrylate-resin-based and styrene-free anchoring mortar
<b>MasterFlow 960</b>	Very fine fast-setting single-component fluid cementitious anchoring grout for structural repairs of threaded rods and bars (suitable down to $-5^{\circ}\text{C}$ )



Anchoring of steel rebar with MasterFlow 960





## MasterInject: Injection for Concrete Structures

Wastewater treatment structures like basins and reservoirs function in harsh environments where structure movements can lead to concrete cracks. The cracks allow contaminated water to penetrate into concrete structure damaging the reinforcement and accelerating the concrete deterioration.

### Diagnostic

A diagnostic test of the structure must be performed to determine the reasons for the cracks before any repair and treatment can begin.

### Prevention

A crack-bridging membrane reduce the risk of leakage and thus increases safety, as well as limiting costly downtime by extending the life cycle of the structure.

### Compatible MasterInject products

<b>MasterInject 1325</b>	Flexible low-viscosity immediate-foaming PU-based injection resin
<b>MasterInject 1330</b>	Flexible low-viscosity fast-setting PU-based and water-tolerant injection resin
<b>MasterInject 1360</b>	Low-viscosity epoxy-based injection resin
<b>MasterInject 1380</b>	Fast-setting low-viscosity epoxy-based and water-tolerant injection resin



Crack injection in a concrete wall with MasterInject 1360







## Risk Management: From Products to Successful Projects



### 1. Experience

Our Master Builders Solutions experts solve many challenges on jobsites worldwide, as is shown by our extensive list of references.

Our comprehensive Master Builders Solutions range of waterproofing systems is documented and certified according to its use on various building areas in different countries across Europe.

### 2. Design and specification

Our Master Builders Solutions experts contribute to the analysis and design process, combining various individual products into complete system solutions.

### 4. Detailing

We understand the necessary products and solution approaches, including details that are often neglected (e.g., joints, transition points, and penetrations), even though they are the most vulnerable areas.

### 3. Product systems

Required high-performance products and other applications must be designed and certified for their specific intended use.



The management of wastewater treatment structures is a big responsibility. Reducing the risk of unexpected maintenance is a major decision driver when choosing the right waterproofing and repair solution. The right product addresses all needs, requirements, and regulations, while

lengthening the life cycle of the structure. Each step in the wastewater treatment requires a specific approach. A durable solution easily reduces downtime and overall costs. Master Builders Solutions can help you find the right product for your specific project requirements.



## Access to Support and More Information



### MasterSeal 7000 CR: 360-degree protection for extreme conditions

MasterSeal 7000 CR is a unique crack-bridging and chemical-resistant waterproofing system for the wastewater treatment industry. Find out more on [www.masterseal-7000cr.basf.com](http://www.masterseal-7000cr.basf.com)



### Master Builders Solutions online planning tool

[www.online-planning.construction.basf.com](http://www.online-planning.construction.basf.com)



### Technical support and services

Our knowledge and expertise is available to you from the conception to the completion of your construction project. Find your Master Builders Solutions expert here: [www.master-builders-solutions.basf.co.uk/en-gb/contact](http://www.master-builders-solutions.basf.co.uk/en-gb/contact)



We offer you easy application videos for the Master Builders Solutions products on our YouTube channel. Find out more at: [www.youtube.com/basf](http://www.youtube.com/basf)



## DO YOU ALREADY KNOW OUR SUSTAINABILITY CAMPAIGN?

COST SAVINGS

PERFORMANCE BENEFITS

FOOTPRINT REDUCTION



DISCOVER OUR CUSTOMER SUCCESS STORIES AND WATCH THE MOVIES!

[sustainability.master-builders-solutions.basf.com](http://sustainability.master-builders-solutions.basf.com)





## Master Builders Solutions from BASF



### Master Builders Solutions

The Master Builders Solutions brand brings all of BASF's expertise together to create chemical solutions for new construction, maintenance, repair and renovation of structures. Master Builders Solutions is built on the experience gained from more than a century in the construction industry.

The know-how and experience of a global community of BASF construction experts form the core of Master Builders Solutions. We combine the right elements from our portfolio to solve your specific construction challenges. We collaborate across areas of expertise and regions and draw on the experience gained from countless construction projects world-wide. We leverage global BASF technologies, as well as our in-depth knowledge of local building needs, to develop innovations that help make you more successful and drive sustainable construction.

### Our comprehensive portfolio

- Concrete admixtures
- Cement additives
- Chemical solutions for underground construction
- Waterproofing solutions
- Sealants
- Concrete repair and protection solutions
- Performance grouts
- Performance flooring solutions



**Please do not hesitate to  
 contact us for more specific  
 information!**





# Master Builders Solutions from BASF for the Construction Industry

## MasterAir

Complete solutions for air entrained concrete

## MasterBrace

Solutions for concrete strengthening

## MasterCast

Solutions for the manufactured concrete product industry

## MasterCem

Solutions for cement manufacture

## MasterEase

Low viscosity for high performance concrete

## MasterEmaco

Solutions for concrete repair

## MasterFinish

Solutions for formwork treatment and surface improvement

## MasterFlow

Solutions for precision grouting

## MasterFiber

Comprehensive solutions for fiber reinforced concrete

## MasterGlenium

Solutions for high performance concrete

## MasterInject

Solutions for concrete injection

## MasterKure

Solutions for concrete curing

## MasterLife

Solutions for enhanced durability

## MasterMatrix

Advanced rheology control for concrete

## MasterPel

Solutions for water tight concrete

## MasterPolyheed

Solutions for mid-range concrete

## MasterPozzolith

Solutions for water-reduced concrete

## MasterProtect

Solutions for concrete protection

## MasterRheobuild

Solutions for high strength concrete

## MasterRoc

Solutions for underground construction

## MasterSeal

Solutions for waterproofing and sealing

## MasterSet

Solutions for set control

## MasterSuna

Solutions for sand and gravel in concrete

## MasterSure

Solutions for extraordinary workability retention

## MasterTop

Solutions for industrial and commercial floors

## Master X-Seed

Advanced accelerator solutions for concrete

## Ucrete

Flooring solutions for harsh environments



## QUANTIFIED SUSTAINABLE BENEFITS ADVANCED CHEMISTRY BY MASTER BUILDERS SOLUTIONS

**Let the numbers do the talking:** We have portrayed some of our most eco-efficient product solutions for concrete and precast production, construction, civil engineering, and flooring.

[sustainability.master-builders-solutions.basf.com](https://sustainability.master-builders-solutions.basf.com)



### BASF Construction Solutions GmbH

European Marketing  
Salzachstrasse 2-12  
68199 Mannheim ■ Germany  
[www.master-builders-solutions.basf.com](http://www.master-builders-solutions.basf.com)

### BASF Construction Solutions GmbH

Product Management  
c/o PCI Augsburg GmbH  
Piccardstrasse 11  
86159 Augsburg ■ Germany  
[www.master-builders-solutions.basf.com](http://www.master-builders-solutions.basf.com)

The data contained in this publication are based on our current knowledge and experience. They do not constitute the agreed contractual quality of the product and, in view of the many factors that may affect processing and application of our products, do not relieve processors from carrying out their own investigations and tests. The agreed contractual quality of the product at the time of transfer of risk is based solely on the data in the specification data sheet. Any descriptions, drawings, photographs, data, proportions, weights, etc. given in this publication may change without prior information. It is the responsibility of the recipient of our product to ensure that any proprietary rights and existing laws and legislation are observed (04/2017).

® = registered trademark of BASF group in many countries.

EEBE 1614en